







36 200 980

- inverseur rotatif
- rosace 60 x 60 mm



	Chrome	36 200 980-00
	Platine brossé	36 200 980-06
	Laiton brossé (Or 23cts)	36 200 980-28
	Champagne brossé (Or 22cts)	36 200 980-46
	Champagne (Or 22cts)	36 200 980-47
	Dark Platinum brossé	36 200 980-99

### Accessoires requis



- Inverseur à 2 voies à encastrer -** 35 202 970 90
- profondeur de montage max. 160 mm
  - profondeur de montage mini. 85 mm

36 200 980

mm [inches]

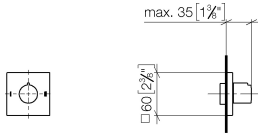

### Diagramme de débit



### Certificats

LGA\_38379.

WRAS\_2307045.

36 200 980

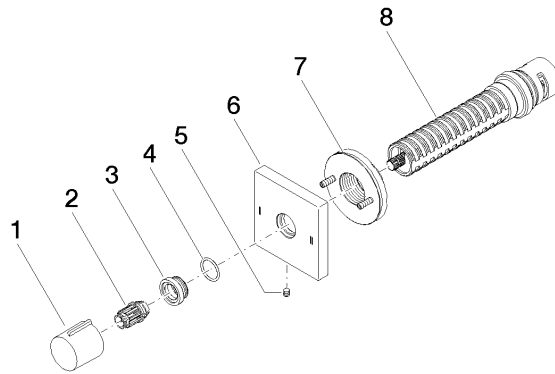

### Liste des pièces de rechange

N°	Article Numéro	Désignation	Fréquence de montage	Délai de livraison
1	09 20 98 001-00	poignée	1	10
2	09 12 12 005 90	douille d'enclenchement	1	2
3	09 12 12 043-00	prise	1	10
4	09 14 10 017 90	joint	1	2
5	09 31 11 294 90	tige	1	2
6	09 27 98 037-00	rosace	1	10
7	90 21 02 181 00 90	rondelle	1	2
8	90 90 03 304 10 90	inverseur	1	2